

## WILLY 60 SUSPENSION

### D81014-BLK

#### GENERAL

Series: Willy  
 Subseries: Willy 60  
 Brand: Panzeri  
 Division: Design  
 Mounting Type: Suspension  
 Mounting Location: Ceiling  
 Subcategory: Pendant

#### PHYSICAL

Shape: Dome  
 Diameter (mm): 600  
 Diameter (in): 23 5/8  
 Height (mm): 370  
 Height (in): 14 7/16  
 Max. Overall Height (mm): 2370  
 Max. Overall Height (in): 93 5/16  
 Light Distribution: Direct / Indirect  
 Weight (kg): 10.22  
 Weight (lbs): 22.53  
 Diffuser: Black Blown Glass Dome and Frosted White Glass Bottom Diffuser  
 Fixture Material: Glass / Aluminum  
 Cable Details: 2000mm (78 3/4") Long Steel Suspension Cables / 2200mm (86 5/8") Long Power Cable In Transparent PVC

#### ELECTRICAL

Number of Lamps: 3  
 Lamp Type: LED Retrofit  
 Bulb Included: Bulb Not Included  
 Total Output Wattage (W): 45  
 Max. Wattage Per Lamp (W): 15  
 Lamp Base: E26  
 Input Voltage (V): 120

#### LED

#### OPTICAL

#### RATINGS AND CERTIFICATIONS

Certified By: CSA Certified to UL and CSA Standards  
 IP rating: IP20

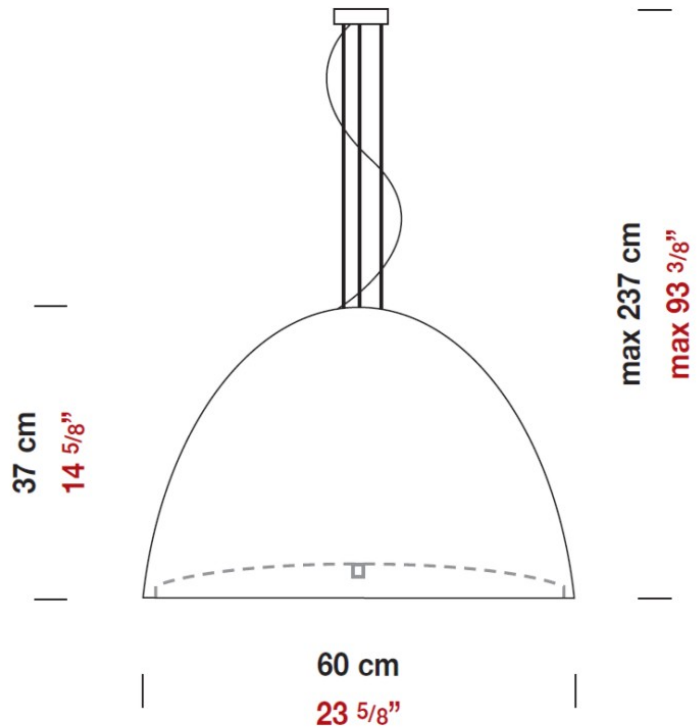

## WILLY 40 SUSPENSION

### D81057-BLK

#### GENERAL

Series: Willy \_\_\_\_\_

Subseries: Willy 40 \_\_\_\_\_

Brand: Panzeri \_\_\_\_\_

Division: Design \_\_\_\_\_

Mounting Type: Suspension \_\_\_\_\_

Mounting Location: Ceiling \_\_\_\_\_

Subcategory: Pendant \_\_\_\_\_

#### PHYSICAL

Shape: Dome \_\_\_\_\_

Diameter (mm): 400 \_\_\_\_\_

Diameter (in): 15 <sup>3</sup>/<sub>4</sub> \_\_\_\_\_

Height (mm): 280 \_\_\_\_\_

Height (in): 11 \_\_\_\_\_

Max. Overall Height (mm): 2280 \_\_\_\_\_

Max. Overall Height (in): 89 <sup>3</sup>/<sub>4</sub> \_\_\_\_\_

Light Distribution: Direct \_\_\_\_\_

Weight (kg): 4.09 \_\_\_\_\_

Weight (lbs): 9.02 \_\_\_\_\_

Diffuser: Black Blown Glass Dome and Frosted White Glass Bottom \_\_\_\_\_

Fixture Finish: BLK \_\_\_\_\_

Holder Finish: Metallized Gray \_\_\_\_\_

Fixture Material: Blown Glass Lampshade \_\_\_\_\_

Cable Details: 2000mm (78 3/4") Long Steel Suspension Cables /  
2200mm (86 5/8") Long Power Cable In Transparent PVC \_\_\_\_\_

#### ELECTRICAL

Number of Lamps: 1 \_\_\_\_\_

Lamp Type: LED Retrofit \_\_\_\_\_

Lamp Shape: A19 \_\_\_\_\_

Bulb Included: Bulb Not Included \_\_\_\_\_

Total Output Wattage (W): 15 \_\_\_\_\_

Max. Wattage Per Lamp (W): 15 \_\_\_\_\_

Lamp Base: E26 \_\_\_\_\_

Driver Included: No \_\_\_\_\_

Input Voltage (V): 120 \_\_\_\_\_

#### LED

#### OPTICAL

#### RATINGS AND CERTIFICATIONS

Certified By: CSA Certified to UL and CSA Standards \_\_\_\_\_

IP rating: IP20 \_\_\_\_\_

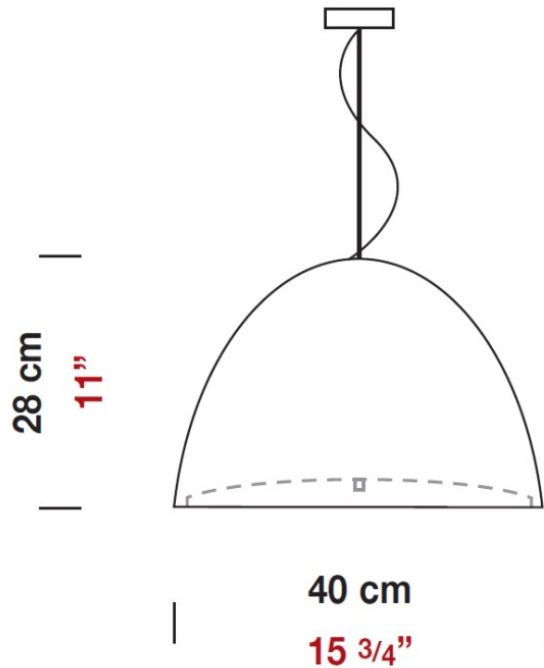

D

PROJECT	_____
TYPE	_____
NOTES	_____
QUANTITY	_____
DATE	_____

## WILLY 40 SUSPENSION

### D81057-WHI

#### GENERAL

Series: Willy  
 Subseries: Willy 40  
 Brand: Panzeri  
 Division: Design  
 Mounting Type: Suspension  
 Mounting Location: Ceiling  
 Subcategory: Pendant

#### PHYSICAL

Shape: Dome  
 Diameter (mm): 400  
 Diameter (in): 15 3/4  
 Height (mm): 280  
 Height (in): 11  
 Max. Overall Height (mm): 2280  
 Max. Overall Height (in): 89 3/4  
 Weight (kg): 4.09  
 Weight (lbs): 9.02  
 Diffuser: White Blown Glass Dome and Frosted White Bottom  
 Fixture Finish: WHI  
 Holder Finish: Metallized Gray  
 Fixture Material: Blown Glass Lampshade

#### ELECTRICAL

Number of Lamps: 1  
 Lamp Type: LED Retrofit  
 Bulb Included: Bulb Not Included  
 Total Output Wattage (W): 15  
 Max. Wattage Per Lamp (W): 15  
 Lamp Base: E26  
 Driver Included: No  
 Input Voltage (V): 120

#### LED

#### OPTICAL

#### RATINGS AND CERTIFICATIONS

Certified By: CSA Certified to UL and CSA Standards  
 IP rating: IP20

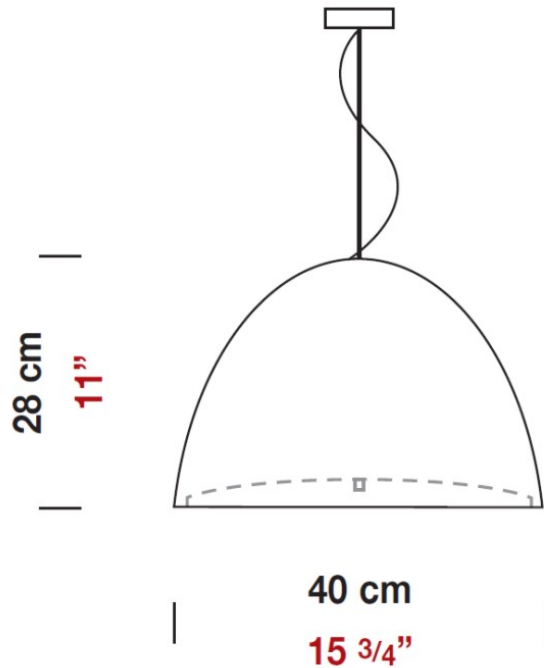

## WILLY SUSPENSION

### D81060

#### GENERAL

Series: Willy

Brand: Panzeri

Division: Design

Mounting Type: Suspension

Mounting Location: Ceiling

Subcategory: Pendant

#### PHYSICAL

Shape: Bell

Diameter (mm): 160

Diameter (in): 6 ¼

Height (mm): 250

Height (in): 9 ⅞

Max. Overall Height (mm): 2250

Max. Overall Height (in): 88 ⅞

Light Distribution: Direct

Weight (kg): 1.23

Weight (lbs): 2.7

Diffuser: Black Blown Glass

Fixture Finish: Metallic Gray

Fixture Material: Metal

#### ELECTRICAL

Number of Lamps: 1

Lamp Type: LED Retrofit

Lamp Shape: T4

Bulb Included: Bulb Not Included

Total Output Wattage (W): 3

Max. Wattage Per Lamp (W): 3

Lamp Base: G9

Input Voltage (V): 120

#### LED

#### OPTICAL

#### RATINGS AND CERTIFICATIONS

Certified By: CSA Certified to UL and CSA Standards

IP rating: IP20

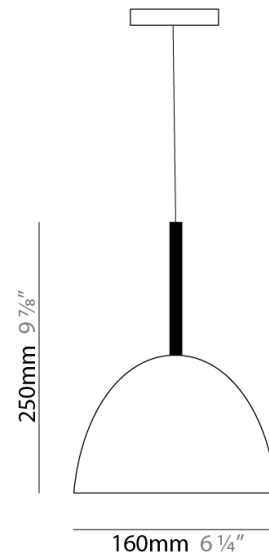

PROJECT	_____
TYPE	_____
NOTES	_____
QUANTITY	_____
DATE	_____

## WILLY SUSPENSION

### D81344

#### GENERAL

Series: Willy  
Brand: Panzeri  
Division: Design  
Mounting Type: Suspension  
Mounting Location: Ceiling  
Subcategory: Pendant

#### PHYSICAL

Shape: Bell  
Diameter (mm): 600  
Diameter (in): 23 5/8  
Height (mm): 370  
Height (in): 14 9/16  
Max. Overall Height (mm): 2370  
Max. Overall Height (in): 93 5/16  
Light Distribution: Direct  
Weight (kg): 12.2  
Weight (lbs): 27  
Diffuser: Metallic Gray Aluminum Dome and Frosted White Glass Bottom Diffuser  
Fixture Finish: ALU  
Fixture Material: Aluminum

#### ELECTRICAL

Number of Lamps: 3  
Lamp Type: LED Retrofit  
Bulb Included: Bulb Not Included  
Total Output Wattage (W): 45  
Max. Wattage Per Lamp (W): 15  
Lamp Base: E26  
Input Voltage (V): 120  
Upon Request: 277Vac / GU24

#### LED

#### OPTICAL

#### RATINGS AND CERTIFICATIONS

Certified By: CSA Certified to UL and CSA Standards  
IP rating: IP20

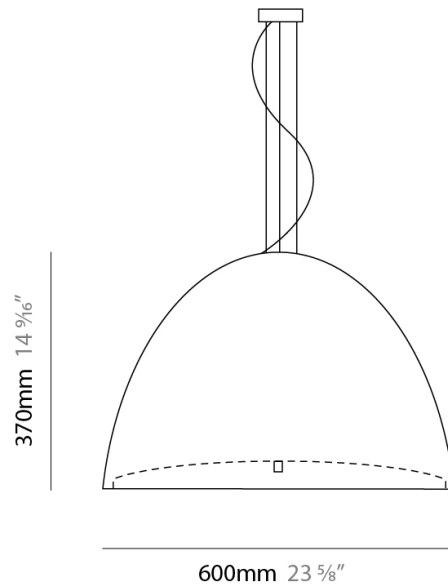

## WILLY SUSPENSION

### D81564-BLK

#### GENERAL

Series: Willy  
Brand: Panzeri  
Division: Design  
Mounting Type: Suspension  
Mounting Location: Ceiling

#### PHYSICAL

Diameter (mm): 1000  
Diameter (in): 39 <sup>3</sup>/<sub>8</sub>  
Height (mm): 630  
Height (in): 24 <sup>13</sup>/<sub>16</sub>  
Max. Overall Height (mm): 2630  
Max. Overall Height (in): 103 <sup>7</sup>/<sub>16</sub>  
Light Distribution: Direct  
Weight (kg): 15.2  
Weight (lbs): 33.5  
Diffuser: Black Polyethylene Dome and White Frosted Opal Glass Bottom Diffuser  
Fixture Material: Polyethylene Lampshade  
Cable Details: Transparent

#### ELECTRICAL

Input Wattage Range: 30 - 49 W  
Lamp Type: LED  
Input Wattage (W): 40  
Total Output Wattage (W): 40  
Driver Included: Yes  
Driver Type: Integral LED Driver in Canopy  
Constant Current (MA): 1050

#### LED

Color Temperature (°K): 3000  
Max. Delivered Lumen (lm): 3859  
CRI: >80 CRI  
Efficiency (%): 78.12

#### OPTICAL

#### RATINGS AND CERTIFICATIONS

Certified By: CSA Certified to UL and CSA Standards

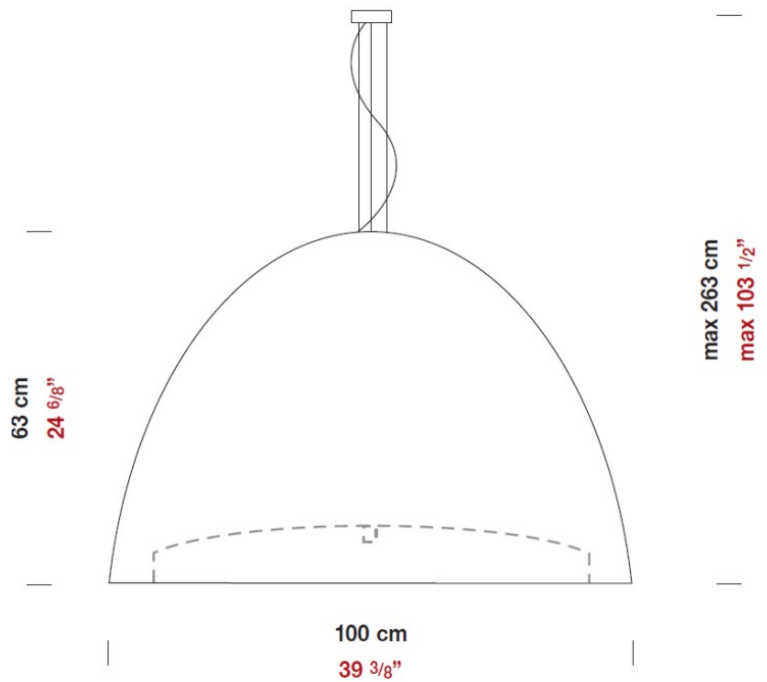

PROJECT	_____
TYPE	_____
NOTES	_____
QUANTITY	_____
DATE	_____

## WILLY SURFACE

### D83027

#### GENERAL

Series: Willy  
Brand: Panzeri  
Division: Design  
Mounting Type: Surface  
Mounting Location: Wall  
Subcategory: Uplight

#### PHYSICAL

Shape: Dome  
Length (mm): 260  
Length (in): 9 7/8  
Height (mm): 210  
Height (in): 8 1/4  
Extension (mm): 130  
Extension (in): 5 1/8  
Light Distribution: Omnidirectional  
Weight (kg): 1.63  
Weight (lbs): 3.6  
Diffuser: Matte White Blown Glass  
Fixture Finish: Metallic Gray  
Fixture Material: Glass / Aluminum

#### ELECTRICAL

Number of Lamps: 1  
Lamp Type: LED Retrofit  
Lamp Shape: T4  
Bulb Included: Bulb Not Included  
Total Output Wattage (W): 5  
Max. Wattage Per Lamp (W): 5  
Lamp Base: G9  
Input Voltage (V): 120

#### LED

#### OPTICAL





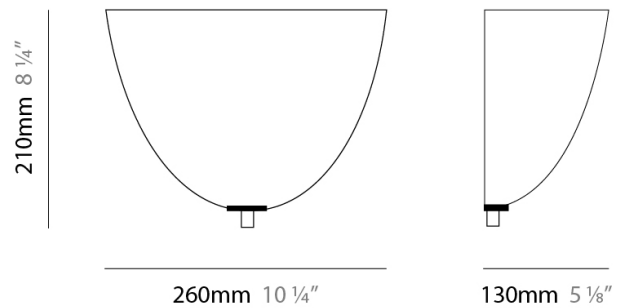































































#### RATINGS AND CERTIFICATIONS

Certified By: CSA Certified to UL and CSA Standards  
IP rating: IP20





## LEGEND

	floor-mounted		pivotal		special LED (upon request) RGB, RGBW, tunable, gold+, meat+, art+, fashion+
	wall and ceiling: recessed and surface mounted		rotating		warm dim / natural dimming LED
	ceiling-mounted and wall-mounted		illuminate tilted		rechargeable battery powered
	wall-mounted		color of suspension cable		fixture with natural vivid LED (upon request)
	omni-directional light distribution		length of suspension cable		color rendering index
	direct light distribution		reflector degree selection		color temperature
	direct/indirect light distribution		super spot		lumen (luminous flux)
	indirect light distribution		lens		efficacy (lumens per watt)
	asymmetric light distribution		lens pack		Unified Glare Rating (UGR) range from 5-40
	aura light distribution		shine ring		marine grade (AISI 316 stainless steel)
	round wall or ceiling cut-out		integrated shine ring with diffuser		walk on
	square wall or ceiling cut-out		free individual colors 01-29		drive on
	the supplied jig specifies the cutout dimensions		individual colors: 00 (free of charge), 01-25 (extra charge)		Dark Sky Compliance
	minimum distance (meters) lamp - object		luminaire part to be colored (F1)		Americans with Disabilities Act (less than 4" off the wall located between 27"-84" from floor)
	recessed depth		luminaire part to be colored (F2)		lamp protected against explosion
	ceiling thickness in mm		luminaire part to be colored (F3)		blown glass using traditional methods by master glass blower
	ceiling thickness selection		luminaire part to be colored (F4)		acoustic material
	dimmable DP (phase), DV (0-10V), DD (dali), DS (step-dim)		luminaire part to be colored (F5)		protection class I, protection insulation
	included or excluded LED driver/transformer/control gear		color of 3-circuit adaptor		protection class II, protection insulation
	separately switchable		indirect diffuser		ETL Certified to UL and CSA Standards
	sensor		direct diffuser		UL Certified to UL and CSA Standards
	remote control		ball-proof (upon request)		CSA Certified to UL and CSA Standards
	available upon request		accessory		Certified for North American Standards

## IP RATING

	protected against ingress of solid bodies greater than 12.5mm (finger)
	protected against ingress of solid bodies greater than 2.5mm protected against sprays of water up to 60 degrees from the vertical (rain)
	protected against ingress of solid bodies greater than 1mm (wire) no protection against the ingress of moisture
	protected against ingress of solid bodies greater than 1mm (wire) protected against sprays of water up to 60 degrees from the vertical (rain)
	protected against ingress of solid bodies greater than 1mm (wire) protected against water splashed from all directions
	protected against limited ingress of dust (wet rooms/covered outdoor areas) protected against water splashed from all directions
	protected against ingress of dust protected against jets of water
	protected against ingress of dust protected against powerful jets of water or heavy seas
	protected against ingress of dust protected against immersion of water between 15cm - 1m for 30 minutes
	protected against ingress of dust protected against immersion of water under pressure for long periods

## IK RATING

	protected against 0.14 joules impact (equivalent to 0.25kg mass dropped from 56mm above the surface)
	protected against 0.2 joules impact (equivalent to 0.25kg mass dropped from 80mm above the surface)
	protected against 0.35 joules impact (equivalent to 0.25kg mass dropped from 140mm above the surface)
	protected against 0.5 joules impact (equivalent to 0.25kg mass dropped from 200mm above the surface)
	protected against 0.7 joules impact (equivalent to 0.25kg mass dropped from 280mm above the surface)
	protected against 1 joules impact (equivalent to 0.25kg mass dropped from 400mm above the surface)
	protected against 2 joules impact (equivalent to 0.5kg mass dropped from 400mm above the surface)
	protected against 5 joules impact (equivalent to 1.7kg mass dropped from 300mm above the surface)
	protected against 10 joules impact (equivalent to 5.0kg mass dropped from 200mm above the surface)
	protected against 20 joules impact (equivalent to 5.0kg mass dropped from 400mm above the surface)